

THE HEATS OF DILUTION OF STRONG ELECTROLYTES

E. LANGE

Division of Physical Chemistry, Chemical Laboratory of the Bavarian Academy of Sciences, Munich, Germany

AND

A. L. ROBINSON

Department of Chemistry, University of Pittsburgh, Pittsburgh, Pennsylvania

Received January 11, 1931

INTRODUCTION

With the appearance of Debye and Hückel's theory of strong electrolytes (1) increased interest and importance became attached to the values of the heats of dilution of these substances as one means for testing and widening the applicability of the theory. Gross and Halpern (2) and Bjerrum (3) treated the theoretical derivation more strictly and the latter derived the following expression for the integral heat of dilution of a strong electrolyte as a limiting expression for extreme dilutions, the ions being regarded as point charges.

$$V_c = - \frac{k T \kappa^3}{8 \pi} \left(1 + \frac{T}{D} \frac{dD}{dT} \right) \text{ calories per mole of salt} \quad (1)$$

$$\kappa^2 = \frac{4 \pi e^2}{DkT} \sum n_j z_j^2$$

e = elementary quantum of electricity,
 D = dielectric constant of the medium,
 k = gas constant per molecule,
 T = absolute temperature,
 n_j = number per cubic centimeter, and
 z_j = valence of an ion of the j th kind.

A comparison with the then available data obtained in dilute solutions—measurements of Richards and Rowe (4) on uni-univalent salts which extended to a minimum concentration of 1 mole salt plus 400 moles water—showed that the experimental values did not agree at all with equation 1; the measured heats of dilution were in a number of cases not even of the predicted positive sign. Bjerrum (5) later attempted to explain these anomalies by use of the parameter 'a' (an average value of the closest distance of approach of two ions in the solution) introduced by Debye and Hückel, suggesting that 'a' varied with T ; also that the effective dielectric constant decreased in the immediate neighborhood of the ions. At about the same time measurements were made in more dilute solutions by Nernst and Orthman (6) which still gave negative heats of dilution for several of the salts measured, even at the lowest concentration. In 1927 it was shown independently by the same authors (7) and by Lange and Messner (8) that at sufficiently great dilution the heat of dilution was positive for all salts measured and that for 1-1 salts the observed values agreed fairly well with each other, as demanded by the limiting form of the Debye-Hückel theory. A more exact treatment of the fundamental theory of Debye and Hückel by Gronwall, LaMer and Sandved (9) was applied by Lange and Meixner (10) to a new calculation of theoretical integral heats of dilution, giving the following expression

$$V_c = -\frac{N}{n} \sum_{j=1}^s n_j \frac{z_j e}{Da_j} \left[\psi_j - \frac{z_j e}{Da_j} \right] \left[1 + \frac{T}{D} \frac{dD}{dT} \right] \text{ ergs per mole of salt} \quad (2)$$

The integral heat of dilution is accordingly equal to the ionic electrical potential energy at the concentration c (expressed in moles of salt per liter of solution) less that at infinite dilution multiplied by the factor $\left(1 + \frac{T}{D} \frac{dD}{dT} \right)$ which is characteristic of the solvent alone. It is important to observe that the following assumptions are made use of in the derivation of this expression: (1) strong electrolytes are completely dissociated at all concentrations; (2) the ions are rigid charged spheres with average least distances of approach 'a'; (3) only Coulomb forces act between the ions (11);

(4) the influence of the solvent is represented by its dielectric constant alone, the value of D (12) being independent of the number and nature of the ions present, $dD/dc = 0$; (5) the distribution of the ions in the solution is determined by their thermal motion and the Coulomb forces acting among them, the only individual factor being the value of the parameter 'a'; the combined use of Boltzmann's and Poisson's equations gives an accurate picture of this ionic distribution (13); (6) in developing equation 2 the additional assumption $d'a'/dT = 0$ is necessary.¹

For aqueous solutions at room temperature equation 2 also demands that V_c should always be positive,² i.e., heat should be evolved by the dilution. For extreme dilutions the limiting law retains its validity and V_c becomes proportional to \sqrt{c} ($V_c = A\sqrt{c}$).

To evaluate V_c , experimental values for D and dD/dT must be substituted in equation 2. In table 1 are compared the most important measurements reported in the literature to date, together with values for $\left(1 + \frac{T}{D} \frac{dD}{dT}\right)$ and A for 1-1 salts calculated from these measurements.

It is seen that the values of $\left(1 + \frac{T}{D} \frac{dD}{dT}\right)$ and A are very sensitive to small changes in dD/dT . Certainly dD/dT for water is not known with sufficient accuracy (15) to permit a comparison of measured integral heats of dilution with those calculated from equation 2. It would be necessary to know dD/dT with an accuracy of ± 0.5 per cent, an accuracy which has probably not yet been reached with the experimental means available today. Perhaps the reason for the lack of agreement lies in some systematic errors peculiar to the various methods employed (16).

The correct values probably lie between those of Drude (14b) and those of Wyman (14i) given in table 1, but for the present a direct numerical comparison does not seem worth while. The theory can still be tested however with respect to the predicted

¹ Since this article was submitted, Scatchard has pointed out (J. Am. Chem. Soc. 53, 2037 (1931)) the omission of a term in $d \ln V/d \ln T$ from equation 2, which would reduce the slope A in the limiting law by about 7 per cent for water.

² In the notation of Lewis and Randall, "Thermodynamics," p. 88, $V_c = -n_1 \bar{L}_1 - \bar{L}_2$, where n_1 moles of water contain one mole of salt.

TABLE I
 Values of D , dD/dT , $\left(1 + \frac{T}{D} \frac{dD}{dT}\right)$ and A for 1-1 salts

AUTHOR	REFERENCE	12.5°C.				25°C.			
		D	$\frac{dD}{dT}$	$\left(1 + \frac{T}{D} \frac{dD}{dT}\right)$	A	D	$\frac{dD}{dT}$	$\left(1 + \frac{T}{D} \frac{dD}{dT}\right)$	A^*
Drude (graphical).....	(14a)	82.77	-0.368	-0.269	351	78.26	-0.349	-0.329	457
Drude (formula).....	(14b)	83.34	-0.379	-0.299	386	78.77	-0.353	-0.337	464
Kockel (graphical), confirmed by De- voto.....	(14c, d)	82.81	-0.404	-0.393	513	77.84	-0.385	-0.474	664
Kockel (formula of Adams).....	(14e)	82.92	-0.436	-0.500	651	77.76	-0.391	-0.500	702
International Critical Tables.....	(14f)	83	-0.4	-0.376	489	78	0.4	-0.528	738
Cuthbertson and Maass (graphical).....	(14g)	79.42	-0.368	-0.323	449	75.40	-0.289	-0.142	209
Drake, Pierce and Dow (formula).....	(14h)	83.29	-0.393	-0.346	448	78.57	-0.362	-0.374	517
Wyman (formula).....	(14i)	83.16	-0.379	-0.300	389	78.54	-0.361	-0.371	513

* See footnote 1.

positive sign of V_c and the proportionality of V_c with \sqrt{c} in the most dilute solutions. It also seems interesting to compare the individuality of heats of dilution within a group of salts of the same valence type—this individuality is predicted by the theory, as each salt will have its own value for 'a'—with the variation of ionic radii as determined from atomic theories and from crystal structure analysis. A test of the justification for the use of D and dD/dT for the solvent in equation 2 can also be made by employing solvents with different dielectric properties.

Approximate values of the integral heats of dilution to be expected below 0.1 M can be estimated from equation 2. For 1-1 type salts at 25°C. we may take 490 as a probable value for A . $V_{0.1} = 490 \sqrt{0.1} = 155$ calories per mole of salt. Strictly speaking, integral heats of dilution cannot be measured directly, since the end concentration can never be made exactly zero and the dilution interval is restricted by the dimensions of the calorimetric apparatus and the volume of the solution to be diluted. Considering these factors, it was estimated that the heat effect accompanying a real dilution in the calorimeter described below could be expected to be of the order of only 0.1 to 0.001 calorie for 1-1 type salts below 0.1 M , corresponding approximately to temperature changes of 1×10^{-3} to 1×10^{-6} degree. These temperature changes should be measured with the greatest accuracy possible, and it was with the above considerations in mind that the calorimeter shown in figure 3 and briefly described below was designed. For more complete details of construction and operation the reader is referred to other publications (17).

APPARATUS

General considerations

A multiple junction thermoelement, in conjunction with a highly sensitive mirror galvanometer, has proved itself best adapted for the measurement of such small temperature changes. The heat effects produced in the calorimeter by the reaction under consideration must be sharply defined and any secondary effects (heats of absorption, conduction, etc.) must be reduced to a minimum. Further, disturbing heat effects caused by thermal

contact of the calorimeter with its surroundings should be eliminated as far as possible. The elimination of external disturbances was accomplished (a) by thermal insulation of the calorimeter from its surrounding bath by the use of a Dewar vessel, (b) by employing an adiabatic method, the temperature of the surrounding bath at any moment during the measurement being held as nearly as possible equal to the temperature inside the calorimeter, (c) by using the differential principle. This principle calls for the use of two symmetrically constructed calorimeter vessels placed under similar conditions in a thermally homogeneous medium, whereby any remaining thermal disturbances between outside and inside are duplicated in both vessels. The small heat effects accompanying the dilution are then produced in one of the calorimeter vessels, under otherwise symmetrical conditions, and the temperature differences before and after the reaction are measured as exactly as possible. An unsilvered Dewar vessel was used as the calorimeter vessel and was divided into two symmetrical halves by the multiple junction thermocouple.

The thermocouple

The thermocouples employed for measuring the small temperature differences produced between the two calorimeter halves were built into the removable partitions that divided the Dewar vessels into two symmetrical parts. The individual elements, 1000 to 1500 in number, were distributed over the greater part of the surface of this partition, since the heat produced by stirring in the two calorimeter halves was probably not homogeneously distributed; the number of thermoelements and their distribution, together with other factors to be mentioned, permitted the temperature differences to be measured with an accuracy of 2×10^{-7} degree.

Two forms of large thermocouples are now in use in this laboratory. Some details of their construction are shown in figure 1 and both are fully described elsewhere.

Type 2 is a newer form (18) and has several advantages over the older form (17). The thermoelements are better insulated from the medium in contact with them. The whole is completely

enclosed in a gilded copper case, the sides and top of which are of German silver, giving greater mechanical sturdiness and still allowing the removal of the vaseline and cleaning of the interior when necessary. Type 2 has a slightly greater lag than type 1 in registering temperature differences, but with the methods employed this is no serious objection.

The 1000 or more thermoelements cover a surface of about 110 square centimeters on either side of the partition, an area equal to approximately three-quarters of the surface of the partition and to one-fifth of the surface in contact with liquid in each calorimeter half.

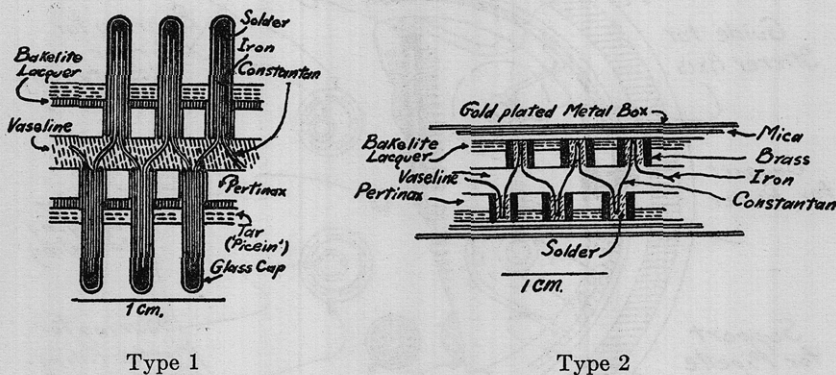

FIG. 1. DETAILS OF MULTIPLE JUNCTION THERMOCOUPLES

The thermal and electrical constants of these thermocouples are discussed below.

The calorimeter vessel

Unsilvered Dewar vessels were used as calorimeters. The following description pertains in particular to a vessel of 2 liters capacity, 200 mm. inner height and 120 mm. inner diameter. Doubts have been frequently expressed as to the advantages obtained by the use of calorimeters with vacuum jackets. Special tests demonstrated clearly the advantages to be obtained.

So that the thermocouples might be removed from the calorimeter when desired they were cemented into Pertinax or hollow German silver frames which had previously been fastened to the

inside of the calorimeter, dividing it into two halves. The frame was cemented to the Dewar vessel with Picein (Portland cement was tried but its use seemed to cause development of strains in the glass and subsequent collapse of the vessel), and the thermocouple, after being pushed into place in the frame, was made tight and fast with a mixture of one part wax and three parts lanolin.

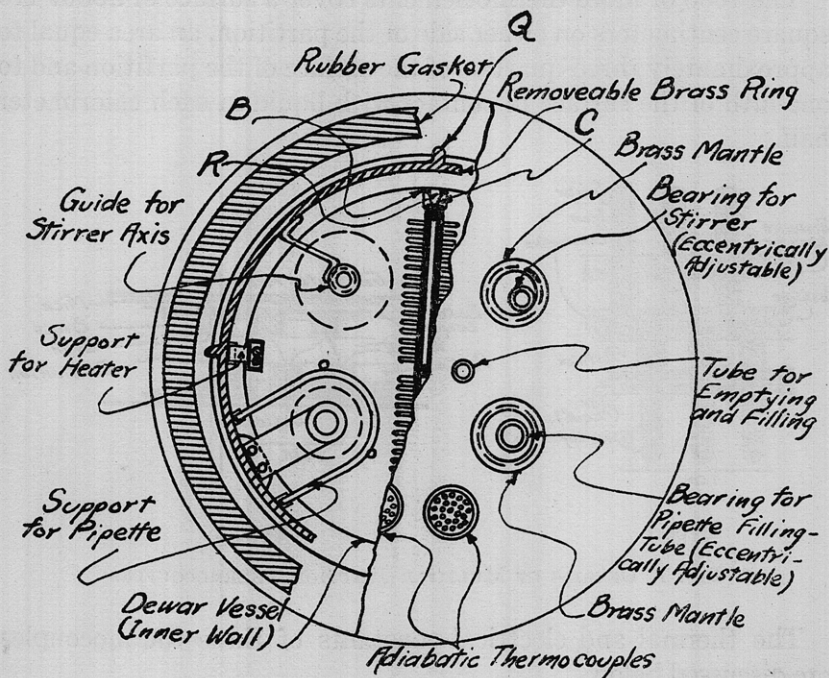

FIG. 2. TOP VIEW OF CALORIMETER VESSEL

The cover is halved

To aid the inserting and removal of the thermocouple an insulated constantan resistance wire was built in between the frame and the thermocouple; electric heating of the wire permitted the easy withdrawal of the thermocouple.

The Dewar vessel was fitted with a lead monoxide-glycerine cement into a flanged brass collar onto which the calorimeter cover, also of brass, was fastened with screw clamps. The vessel

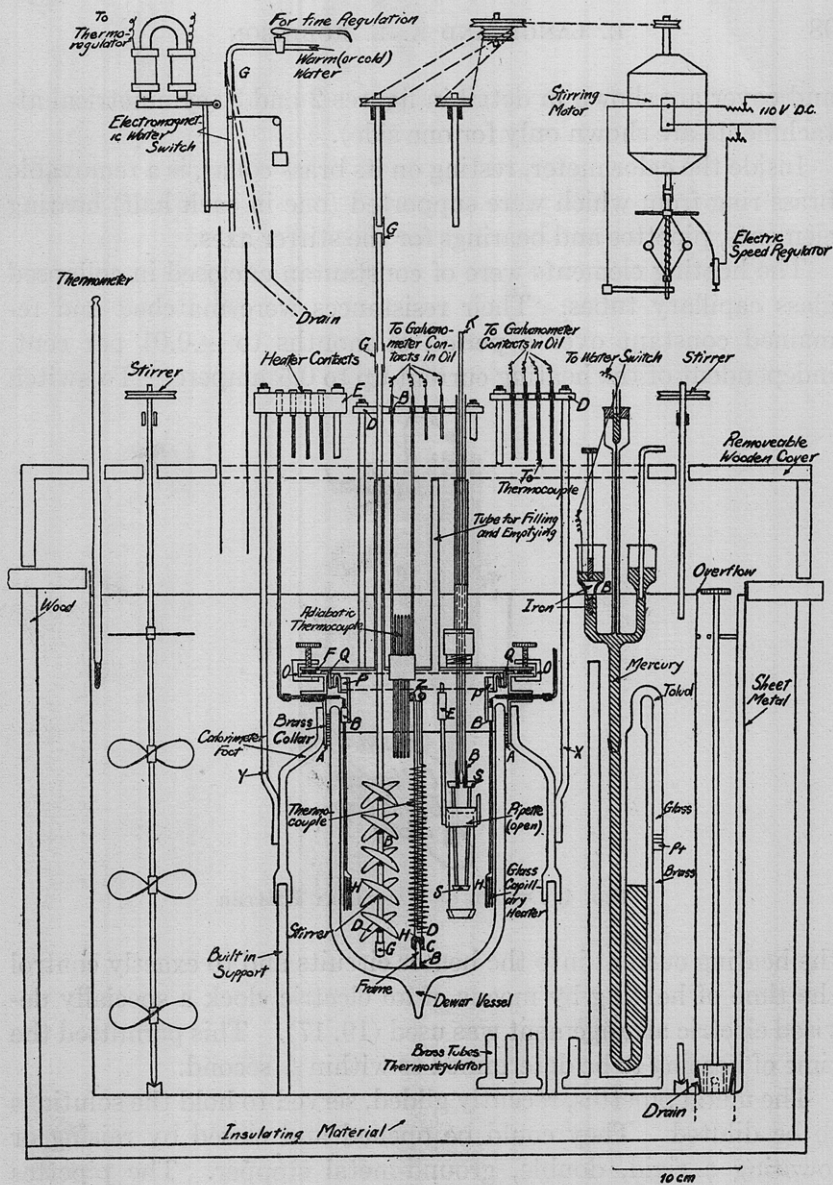

FIG. 3. ADIABATIC DIFFERENTIAL CALORIMETER

A, lead monoxide-glycerine cement; B, Picein; C, lanolin-wax mixture; D, Pertinax; E, hard rubber; F, rubber ring; G, rubber tubing; H, constantan heating wire; O, screw clamps; P, holder for heater; Q, supporting lugs on brass ring; R, Pertinax frame; S, double stopper; X, support for thermocouple leads; Y, support for heater leads.

and cover are shown in detail in figures 2 and 3 (symmetrical attachments are shown only for one side).

Inside the calorimeter, resting on its brass collar, is a removable brass ring from which were supported (one in each half) heating elements, pipettes and bearings for the stirrer axes.

The heating elements were of constantan enclosed in collapsed glass capillary tubes. Their resistances were matched and remained constant over a period of months to ± 0.01 per cent, independent of the heating current up to 0.5 ampere. To switch

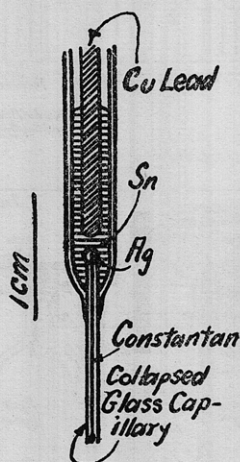

FIG. 4. DETAIL OF CAPILLARY HEATER

the heating current into the heater circuits and to exactly control the time of heating by means of an electric clock a specially devised electric arrangement was used (19, 17). This permitted the time of heating to be determined to within $\frac{1}{100}$ second.

The metal pipettes, recently gilded, served to hold the solutions to be diluted. They could be opened and closed by raising or lowering a rigid, double, ground-metal stopper. The pipettes could also be filled and emptied without being removed from the calorimeter through an opening in the upper stopper, closed or opened as desired by means of a small ground-glass stopper. Thus the volume of the pipettes and the volume of solution to be diluted was always sharply defined.

The stirrers in either half were mirror images of each other and were turned at equal speeds. The constancy of this speed was assured by the use of an electrical speed regulator (19, 17).

Galvanometer and galvanometer readings

A moving-coil mirror galvanometer made by Kipp and Zonen (model Ze) was used to measure the potential developed by the

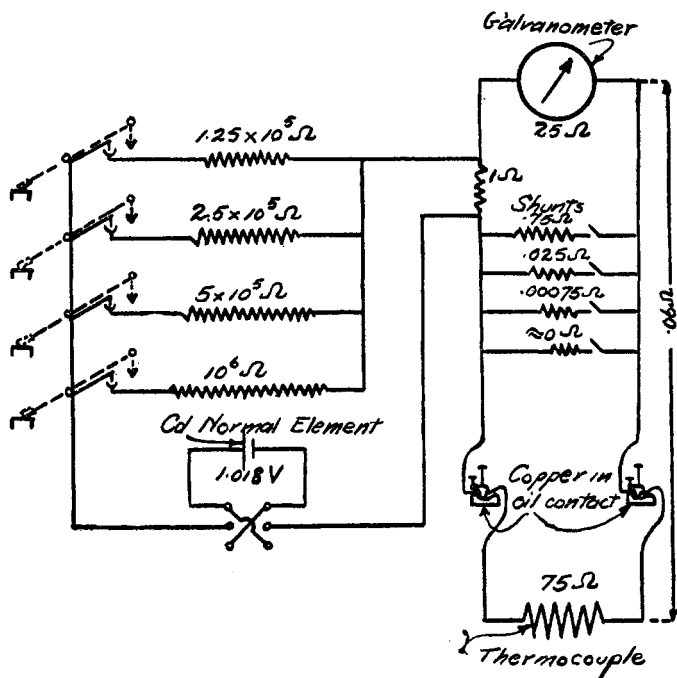

FIG. 5. DIAGRAM OF GALVANOMETER CONNECTION TO THERMOCOUPLE

The diagram shows arrangements for compensating and reducing sensitivity

thermocouple. Its maximum sensitivity was 1.5×10^{-10} ampere per millimeter scale deflection at a distance of one meter. For most of the measurements the sensitivity was reduced to one-eighth of this value by means of an adjustable magnetic shunt. For measurements at the lowest concentrations a sensitivity of about 4.5×10^{-10} ampere per millimeter per meter was used. The internal resistance of the galvanometer was 25 ohms; the

thermocouple connected directly to it had a resistance of about 75 ohms. One binding post of the galvanometer was permanently connected to its case; electrostatic disturbances, otherwise noticeable, were thus eliminated. The leads to the galvanometer were of drilled lead cable, the outer sheathing of which was earthed to further reduce electrostatic and electromagnetic disturbances. The cable was joined to the leads from the thermocouple through contacts of pure copper immersed in water-free mineral oil (17). In general, all contacts were made through pure copper similarly immersed in well-stirred oil thermostats to minimize indefiniteness of contact and stray thermal influences.

To test the sensitivity of the galvanometer during, or before and after, the course of a measurement and to compensate, if necessary, any large galvanometer deflections caused by disturb-

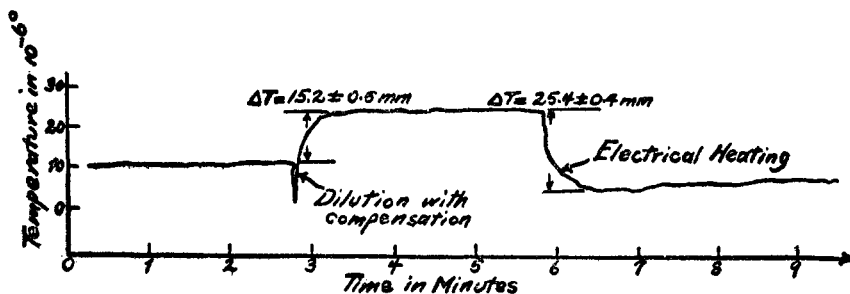

FIG. 6. EXAMPLE OF SEMI-AUTOMATIC ΔT -TIME PLOT DURING A DILUTION WITH ACCOMPANYING WATER VALUE DETERMINATION

ing thermal forces, the arrangement shown in figure 5 was devised. A current of 1×10^{-8} ampere, or stronger currents up to 1.5×10^{-7} ampere, could thus be sent through the galvanometer circuit. With the usual galvanometer sensitivity this corresponded to a deflection of 56.5 mm. at a scale distance of 2.5 meters; this deflection was always reproducible and served to test the working condition of the galvanometer. To protect the highly sensitive galvanometer its sensitivity could be temporarily reduced, up to a millionfold, by means of the four shunts shown.

Galvanometer deflections were observed in the usual way with a telescope; during the course of a measurement readings were

taken at three to four second intervals and plotted on millimeter paper with an accuracy of 0.2 mm. A semi-automatic device was later designed which gave a greater accuracy in the plotting of these readings and relieved the observer of considerable eye strain. A fixed light source (slit with cross thread) fell on the galvanometer mirror and was reflected onto a ground-glass plate 2.5 meters from the galvanometer. This plate was on the sliding carriage of the recording device and was marked with a vertical line. By a suitable gearing device the carriage and a pencil firmly fastened to it could be moved horizontally so that at all times the marker on the plate coincided with the dark thread in the light image. Simultaneously, uniformly rotating rollers carried a piece of millimeter paper under the pencil. A plot so obtained is shown in figure 6.

The outer bath

As is shown later, it was necessary to control the temperature of the water bath surrounding the calorimeter to 0.001°C . or, better, to 0.0001°C . This demanded a thermoregulator with as little lag as possible, a bath well-insulated from the surrounding air, and a rapidly responding heating or cooling source. The thermoregulator (see figure 3) was a comb-shaped system of brass tubes with a surface of 3800 sq. cm. and a volume of 615 cc. to which was attached a glass regulating head. The regulator was filled with toluene which had been freed from sulfur compounds by shaking with mercury and also from air bubbles, and the head contained mercury.

For holding a constant temperature an electric heater was found to have too great a lag. Temperature changes were produced by adding hot or cold water in quantities previously regulated by the fine adjustment of long-handled stop-cocks; electromagnets actuated by the regulator directed this water either into the bath or into a drain, as required. Two and one-half seconds after an addition of hot or cold water, corresponding to a temperature change of 0.001°C ., the regulator responded. A temperature constant to within 0.0002°C . could be maintained for hours. To control the temperature difference between the outer bath and the

inside of the calorimeter an 'adiabatic' thermocouple consisting of 24 iron-constantan elements was built into the calorimeter cover; by means of a light image reflected onto a ground-glass scale this temperature difference could at all times be observed and controlled by the addition of hot or cold water.

MANIPULATION OF THE APPARATUS

For one large thermocouple with 1072 iron-constantan thermoelements, assuming an E.M.F. of 5.1×10^{-5} volt per degree per element, the E.M.F. developed per degree temperature difference was 0.0548 volt. With a total resistance of 100 ohms in the galvanometer circuit this corresponded to a sensitivity of 0.6×10^{-6} degree per millimeter deflection at a scale distance of 3.3 meters and the usual setting of the galvanometer's magnetic shunt; a maximum sensitivity of about 1×10^{-7} degree per millimeter deflection could be obtained. Naturally the thermocouple showed a certain lag in responding to temperature differences (for example, after current had been passed through one of the calorimeter heaters for two seconds the galvanometer first began to register this effect four and one-half seconds after the beginning of the heating and showed a maximum deflection, corresponding to the new thermal E.M.F., five or six seconds later), but this effect was of no great importance, since for the graphical determination of temperature differences the ΔT -time plot was taken for some minutes before and after the reaction. The initial and final portions of these plots were linear and practically parallel over a period of several minutes (see figure 6) and could be extrapolated without much error (usually < 0.5 mm.).

From the heat conductivity constant of the Dewar vessel $\left(\frac{-d\Delta T}{\Delta T \cdot \text{min.}} \approx 0.004 \right)$ and the constancy of the adiabatic control it was calculated that temperature differences between the outer bath and the interior of the calorimeter of the order of 0.0001°C . produced a temperature change in the interior of the calorimeter of $\pm 4 \times 10^{-7}$ degree per minute. Since the two halves of the differential calorimeter were practically equivalent with respect to heat conductivity such disturbances were probably reduced ten-

fold as far as they affected the temperature difference between the two halves. For most of the dilutions the temperature change produced was not greater than 1×10^{-4} degree (of the same order of magnitude as the variation in the adiabatic control) and the method of measurement employed was practically 'isothermal-adiabatic' calorimetry. When larger heats of dilution were measured, corresponding to $\Delta T = 1 \times 10^{-3}$ to 1×10^{-4} degree, with compensating heating (see below) in the cooler half of the calorimeter, the adiabatic error was certainly greater but the relative accuracy of the measurements was not decreased. With negative heats of dilution, i.e., absorption of heat, as a consequence of the compensating heating in the same half, very small temperature changes resulted and the adiabatic error was practically zero.

Possible disturbing factors within the calorimeter were the heat developed by stirring and the thermal conductivity between the two halves through the large thermocouple. Stirring was necessary to insure complete mixing of the solution to be diluted with the body of liquid in the calorimeter and the rapid completion of the reaction. The mirror image construction of the two stirrers and their constant speed produced quantities of heat in the two calorimeter halves which were small and equal; the solutions in the metal pipettes were of course always at a somewhat lower temperature than the liquid in the calorimeter as a result of the lag in the transmission of this heat of stirring, but this effect was eliminated by opening both pipettes when a measurement was made (solution to be diluted in one pipette and calorimeter liquid in the other) and diluting their contents simultaneously.

The effect of conductance between the two calorimeter halves was to diminish any temperature difference produced by a reaction in one-half. For small heats of dilution (less than 40 mm. galvanometer deflection) this reduction amounted to about 5 per cent per minute, an amount small in comparison with other sources of error, so that by linear extrapolation of the initial and final parts of the ΔT -time curves the heat effect could be evaluated to within 1 or 2 per cent. For larger heats of dilution it was found desirable to compensate the ensuing temperature differences by electrical heating—for negative heats of dilution by

heating in the reaction half of the calorimeter and for positive heats by heating in the other half.

To reduce heat effects produced by absorption on the inner wall of the Dewar vessel in some runs the inside of the calorimeter was covered with a thin layer of pure vaseline. However it is believed that such effects in general were not present (20).

The evaluation of such ΔT -time curves as shown in figure 6 assumes that the heat effect produced by the simultaneous opening of both pipettes is produced by the dilution reaction alone. To test this, frequent controls were run; both pipettes, filled with water or with the same solution, were opened together and curves

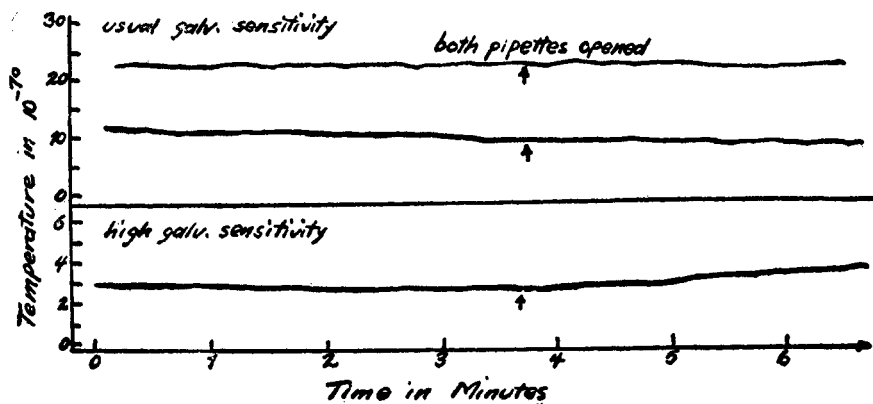

FIG. 7. TYPICAL BLANK RUNS

such as those shown in figure 7 were obtained. The complete absence of effects due to the pipette temperature lagging behind the main calorimeter temperature was thus shown.

Electrical calibration was employed to evaluate the galvanometer deflections produced by dilution reactions in terms of calories. By means of the switching device mentioned above, current was passed through one of the calorimeter heaters for a definite time (two seconds or some multiple thereof) and the galvanometer deflection was obtained in the usual way. A knowledge of the time of heating, resistance of the heater and applied potential permitted an exact evaluation of the galvanometer readings in terms of calories.

RESULTS OF MEASUREMENTS

The experimental results are shown in figures 8, 9, 10 and 11. The extrapolation of the curves from the lowest measured con-

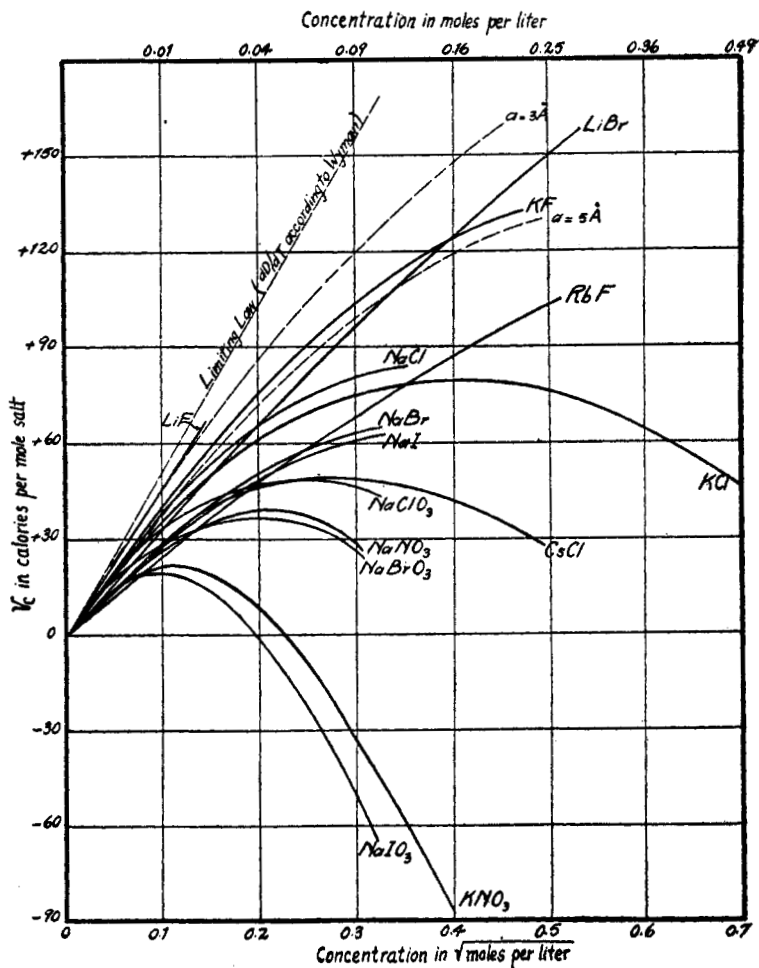

FIG. 8. INTEGRAL HEATS OF DILUTION OF 1-1 SALTS AT 25°C.

LiF (21), LiBr (8), NaCl (22), NaBr (22), NaI (23), NaClO_3 (24), NaBrO_3 (24), NaIO_3 (24), NaNO_3 (24), KF (8), KCl (25), KNO_3 (26), RbF (26), CsCl (8).

centration (1×10^{-4} to $1 \times 10^{-5} M$) to zero concentration is made without any great error; an uncertainty of perhaps one calorie is

introduced into the V_c values by this extrapolation. For the various types of salts the limiting law is also shown (the dielectric

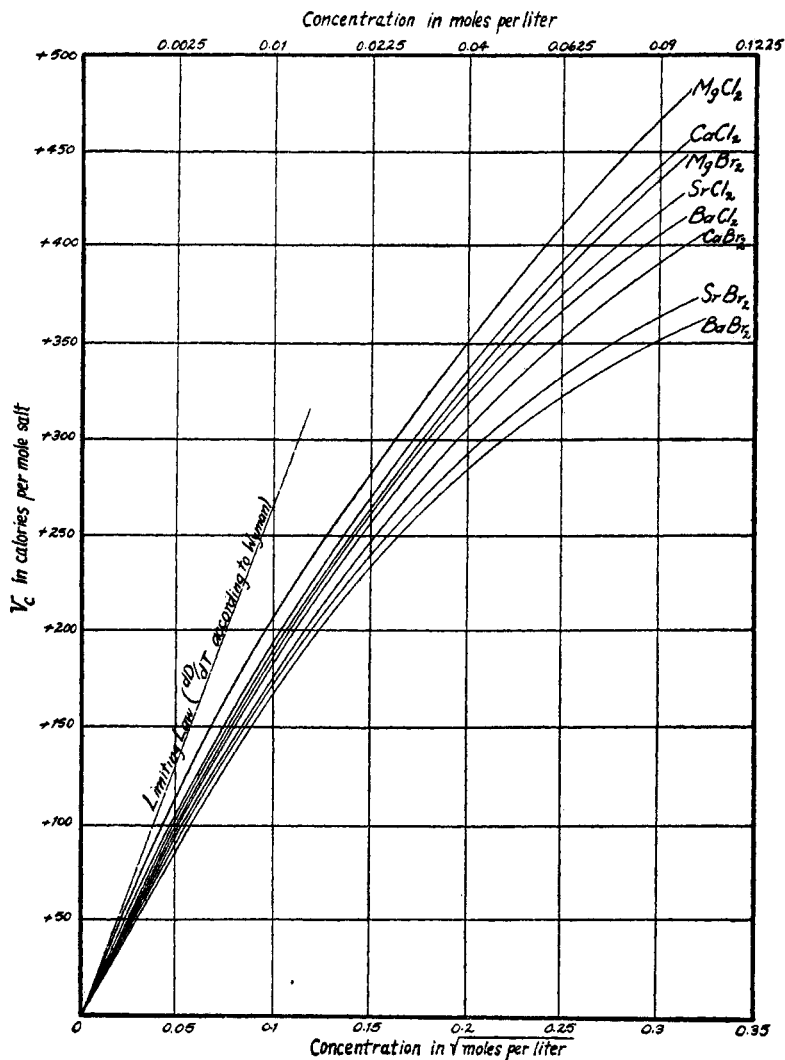

FIG. 9. INTEGRAL HEATS OF DILUTION OF 2-1 SALTS AT 25°C.

$MgCl_2$, $CaCl_2$, $SrCl_2$, $BaCl_2$, $MgBr_2$, $CaBr_2$, $SrBr_2$, $BaBr_2$ (27)

constant measurements of Wyman were used in the calculations); for the 1-1 type theoretical curves for V_c calculated from equation

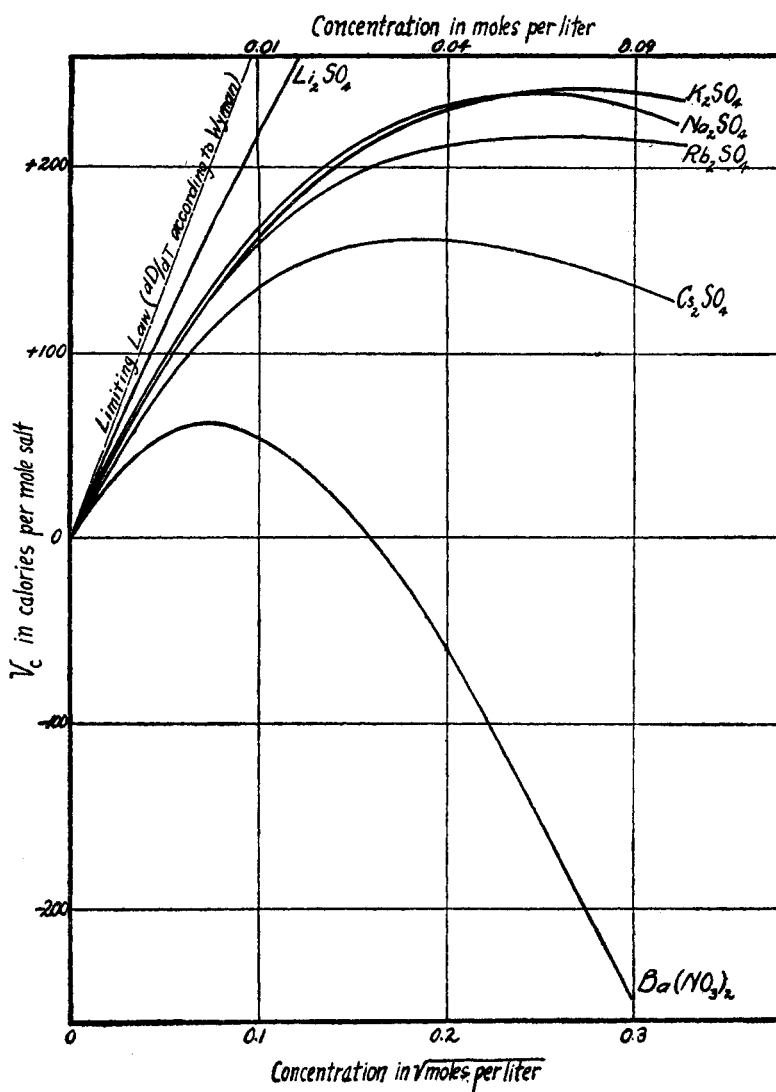

FIG. 10. INTEGRAL HEATS OF DILUTION AT 25°C.
 Li_2SO_4 , Na_2SO_4 , K_2SO_4 , Rb_2SO_4 , Cs_2SO_4 , $Ba(NO_3)_2$ (28)

2 for 'a' values of 3 and 5 Ångström units are also given. For 2-1 (27) and 1-2 type salts the theoretical value of A is 5.2 times as large as for 1-1 salts; for 2-2 type salts the ratio is 8 to 1. A discussion of the causes of the deviations of the observed values from the calculated is given later, although it may be observed at once that the cutting of the curves for salts of the same valence type with a common and variable ion and the appearance of negative values for V_c at moderate dilutions are in complete dis-

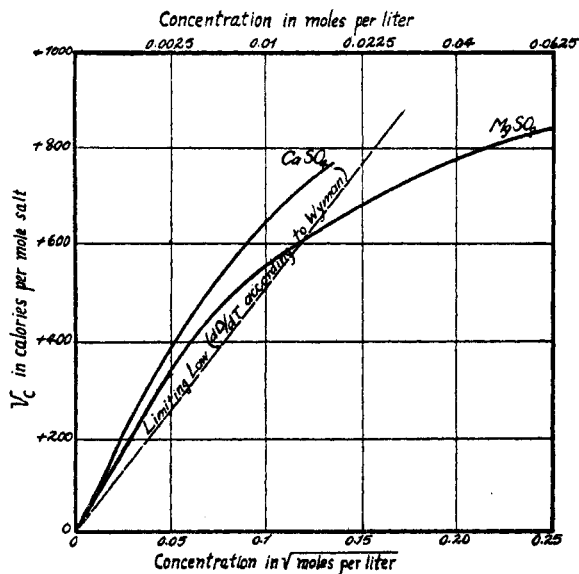

FIG. 11. INTEGRAL HEATS OF DILUTION OF 2-2 SALTS AT 25°C.

CaSO₄ (26), MgSO₄ (8)

agreement with the simple interionic theory with its various assumptions noted above.

From the measured integral heats of dilution it is possible to calculate directly the differential heats of dilution for each salt for the measured concentration range. These differential heats of dilution are necessary for calculating the temperature coefficient of activity and osmotic coefficients (27, 29) and are particularly useful in the calculation of activity coefficients at room temperature from freezing point data. A knowledge of the integral heats of

dilution is necessary in order to make proper corrections of measured heats of precipitation (30) and neutralization (31). Where a heat of solution is to be extrapolated to infinite dilution from some finite concentration the integral heat of dilution is required; this is illustrated in the calculation of ionic entropies (32). This heat of solution at infinite dilution can also be used to test Born's calculation of the lattice energy of solids (33). Although the measurements discussed in this paper were obtained for concentrations in general below 0.1 M , such measurements are easily combined with measurements in more concentrated solutions to obtain curves for the complete solubility range (20).

THEORETICAL DISCUSSION

For all electrolytes on which measurements have been made, positive values for V_c have been found at the lowest concentrations. There can be no doubt that this is true for all electrolytes at sufficiently great dilutions. The theory, with its various assumptions, demands positive V_c values throughout the entire concentration range for completely dissociated electrolytes.

At the lowest measured concentrations the integral heats of dilution increase more or less proportionally with the square root of the concentration expressed in moles of salt per liter of solution (there is no appreciable difference between weight and volume concentrations in this range). This proportionality is found to hold on the average for 1-1 and 2-1 type salts up to concentrations of about 0.01 M , although for individual salts this limit may be higher or lower.³ The slopes found agree well with the theory, considering the uncertainty in dD/dT .

For the various salts measured (this is presumably true for all electrolytes) the V_c values remain individual down to very low concentrations; for 2-1 salts this individuality is still definitely recognizable below $1 \times 10^{-4} M$. This does not agree with the limiting law of the Debye-Hückel theory, according to which all strong electrolytes of the same valence type should have identical

³ The proportionality with \sqrt{c} is better for the 1-1 type salts. The alkaline earth chlorides and bromides show a closer approach to this proportionality than the alkali sulfates and alkaline earth nitrates.

heats of dilution, but it is not in contradiction with the more exact development of the theory (9, 10) in view of the individuality of the 'a' parameter, if for no other reason.

If the different 'a' values of the various salts (they are assumed to be independent of temperature⁴) are alone responsible for the individuality observed, then in any one valence type the electrolytes with the smallest 'a' values should have the highest V_c values. Interpreting the measurements in these terms it is seen that $a_{\text{LiF}} < a_{\text{KF}} < a_{\text{RbF}}; a_{\text{NaCl}} < a_{\text{NaBr}} < a_{\text{NaI}}; a_{\text{MgCl}_2} < a_{\text{CaCl}_2} < a_{\text{SrCl}_2} < a_{\text{BaCl}_2}; a_{\text{MgBr}_2} < a_{\text{CaBr}_2} < a_{\text{SrBr}_2} < a_{\text{BaBr}_2}; a_{\text{Mg}(\text{NO}_3)_2} < a_{\text{Ca}(\text{NO}_3)_2} < a_{\text{Sr}(\text{NO}_3)_2} < a_{\text{Ba}(\text{NO}_3)_2}; a_{\text{Li}_2\text{SO}_4} < a_{\text{Na}_2\text{SO}_4} < a_{\text{K}_2\text{SO}_4} < a_{\text{Rb}_2\text{SO}_4} < a_{\text{Cs}_2\text{SO}_4}$. This would seem to indicate a parallelism between the apparent diameter of ions in solution and the ionic radii as determined from crystal structure analysis. On the other hand the measurements would have to be interpreted as showing $a_{\text{MgSO}_4} > a_{\text{CaSO}_4}$.⁵ In other words, there is not always a parallelism between 'a' and the ionic radius, assuming that the observed slopes A can be interpreted as being caused by different 'a' values alone. It might also be mentioned that even if the observed A values had indicated 'a' values in the inverse order as compared with ionic radii in crystals, as for instance in the case of the alkaline earth sulfates just mentioned, the explanation could be advanced that the smaller ions actually have a larger apparent diameter in solution due to their greater hydration (16). But the comparison of magnesium and calcium ions gives opposing pictures depending on whether these ions are associated with halogen

⁴ By measuring the temperature coefficient of the potential of the cell



LaMer and Cowperthwaite have obtained evidence that 'a' for zinc sulfate is independent of temperature from 0° to 50°C. Professor LaMer has kindly given us this information. Similar results were obtained by him for cadmium sulfate. It seems doubtful that this can be true for all electrolytes. Measurements of the heat of dilution of potassium nitrate and of potassium chloride at 25°C. and 12.5°C. indicate that 'a' for these salts varies with the temperature (16).

⁵ Recent measurements below $4 \times 10^{-5} M$ indicate that at very small concentrations $a_{\text{CaSO}_4} > a_{\text{MgSO}_4}$.

ions or a sulfate ion. The nature of the common ion, as well as the relative values of the ionic radii, seems to determine the relative values of 'a'.

A similar interpretation of activity coefficients determined by E.M.F. or freezing point methods should give the same order for the 'a' values in a series of salts with a common ion, since the theory would obviously require the use of the same 'a' in the theoretical activity coefficient and V_c expressions. Actually, however, this is not the case. Considering the alkali halides, for instance (34), it is found that the salts with higher V_c , and therefore smaller 'a', values have the higher activity coefficients, i.e., apparently the larger 'a'. The same anomaly is shown by the alkaline earth chlorides. According to V_c measurements $a_{\text{CaCl}_2} < a_{\text{SrCl}_2} < a_{\text{BaCl}_2}$, while the activity coefficients (35) give $a_{\text{CaCl}_2} > a_{\text{SrCl}_2} > a_{\text{BaCl}_2}$. It is not impossible that if the activity coefficient measurements could be extended to the same dilution with the same accuracy as the V_c measurements, the observed discrepancies would disappear. But considering the unexpected order of 'a' values already found among the alkaline earth sulfates, it seems more probable that the properties of these electrolytes cannot be explained in terms of 'a' values alone, even in solutions whose concentration is only 0.01 M .⁶

Above 0.01 M the situation is even more complicated. The V_c curves bend toward the abscissa and in some cases (e.g., NaIO_3 , KNO_3 , $\text{Ba}(\text{NO}_3)_2$) even assume negative values at concentrations below 0.1 M . This bending towards negative values is to be expected from the theory, but in most cases is greater than anticipated (LiBr , RbF , and perhaps LiF are exceptions). The curves of salts with a common and a variable ion cut each other in several instances; this too cannot be explained by any present treatment of the Debye-Hückel theory.

Evidently other factors than those considered by equation 2 are responsible for the anomalies mentioned. The existence of undissociated molecules in solutions of strong electrolytes even at concentrations as low as 0.01 M is a possible explanation for the

⁶ A more complete comparison of 'a' values indicated by heat of dilution and activity coefficient measurements is given in *Naturwissenschaften* 19, 359 (1931).

pronounced trend toward negative values (36) of V_e . Above 0.01 M it is possible to explain qualitatively the bending toward negative values as a dissociation effect superposed on the interionic effect. An attempt to find quantitative support for this suggestion gave no definite results. Since the effect of any undissociated portion of a salt should be approximately proportional to the concentration (24), and since salts are probably largely dissociated in 1 M solutions, assuming a molar heat of dissociation of the order of magnitude of 10 kilogram-calories, the contribution of the heat of dissociation to the integral heat of dilution in a 0.01 M solution would probably be less than 10 calories, an amount scarcely sufficient to account for the observed bending of the V_e curves at this concentration. On the other hand the assumption of the presence of undissociated molecules cannot be disproved; the evidence as to their existence is conflicting (37).

Formally it is possible to explain the bending of the V_e curves by the addition of other terms to equation 2, for example, a term involving da/dT . The theoretical treatment of V_e is thereby considerably complicated and no exact expression has as yet been derived in terms of the Gronwall, LaMer and Sandved calculations. However, the original Debye-Hückel treatment involving the parameter ' a ' goes over into this form for large values of ' a ', and it seems useful to investigate the effect of a term involving da/dT for the simpler form of the theory. Gross and Halpern (2) have shown that the added term is proportional to the concentration and negative. Bjerrum (5) has shown that the results of Richards and Rowe at higher concentrations can be explained on this basis if da/dT has small positive or negative values, but does not place any great reliance on this explanation, as at such concentrations the simple interionic theory cannot be expected to be valid. Our results at lower concentrations can also be formally explained by adding a term in da/dT , but, as in the case of the assumption of the existence of undissociated molecules, since the effect is proportional to the concentration it must be negligible at concentrations where the individuality of the V_e curves still persists, to judge from individual deviations at higher concentrations.

Another possibility to be considered is the dependence of the

dielectric constant on the concentration of the salt. The dielectric constants of aqueous salt solutions certainly differ from the dielectric constant of pure water, and presumably dD/dT has an individual value for each salt. Approximate calculations (38) however, have shown that this influence would be proportional to some power of the concentration higher than the square root so that, as in the case of the factors already discussed, the bending of the V_c curves might be explained, but not their individuality at

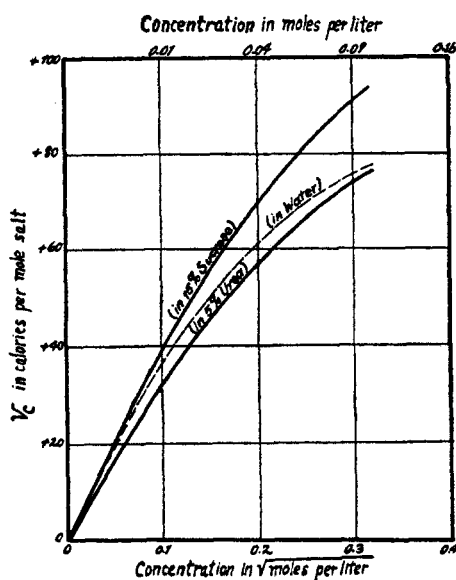

FIG. 12. INTEGRAL HEATS OF DILUTION AT 25°C.

KCl in water (25), KCl in 5% sucrose (39), KCl in 15% urea (39)

such dilutions. Measurements of the dielectric constants of solutions of electrolytes are difficult, and the experimental results obtained thus far are too discordant to be applied to any calculation. The heats of dilution of potassium chloride in 15 per cent urea and 5 per cent sucrose solutions have been measured (39) to see whether the known D and dD/dT values of these solutions (40) would measurably affect the heat of dilution. As is seen from figure 12 the deviations are comparatively small, although from

the constants for the urea solutions ($D = 82.8$, $dD/dT = -0.20$) an initial slope of -228 was to be expected theoretically, i.e., a negative heat of dilution. Either the dielectric constants are subject to large errors, or, as a first approximation, the D and dD/dT values for pure water are to be used in these cases and the observed deviations are to be explained as caused by one or more of the factors discussed above.

It follows from the V_c measurements that the limiting law expression of Debye and Hückel for great dilution is verified not only with respect to the sign of V_c and its approximate proportionality with \sqrt{c} , but also with respect to the numerical values of the initial slopes A , considering the uncertainty in the theoretical values of the dielectric constants. It seems though that the concentration range in which the relatively simple relations of the limiting law are valid lies far below $0.01 M$. Above this limit other effects are certainly present, as indicated by the abnormal bending of the V_c curves toward negative values and the cutting of individual curves. Three possible effects which have been discussed have an action which increases in proportion to the concentration, and if several are present simultaneously it is impossible to predict anything definite about the relationship between V_c and the concentration. It is proposed to extend the measurements to still lower concentrations and to other types of salts, particularly salts of high valence types, to see how far the individual behavior of salts of a definite type persists. The theory of Debye and Hückel at the present time seems to be a good approximation theory, but the individual behavior of electrolytes at such small concentrations means that an exact knowledge of activity coefficients, osmotic coefficients, heats of dilution, etc., can be obtained only by direct measurement.

SUMMARY

A differential adiabatic calorimeter is described which permits the measurement of small temperature differences with an accuracy of 2×10^{-7} degree.

The integral heats of dilution of fourteen 1-1 type salts,

twelve⁷ 2-1 type salts, five 1-2 type salts, and two 2-2 type salts have been measured down to concentrations of about $1 \times 10^{-5} M$ with an average error of 2 per cent.

Below 0.01 M in general the integral heats of dilution are positive in sign (heat is evolved by the dilution), are more or less proportional to the square root of the concentration, and agree fairly well with the slopes calculated from the limiting law of the Debye-Hückel theory, considering the uncertainty existing in the dielectric constant data. The individuality of the integral heat of dilution persists down to the lowest measured concentrations.

Above 0.01 M in general the abnormal bending toward negative values and the cutting of individual curves indicates the influence of factors other than a simple interionic effect. Three possible factors are discussed.

A comparison of the order of the heats of dilution in the alkali and alkaline earth halides with the order of the activity coefficients of these salts shows anomalies even at low concentrations.

REFERENCES

- (1) DEBYE AND HÜCKEL: *Physik. Z.* **24**, 193 (1923).
- (2) GROSS AND HALPERN: *Physik. Z.* **26**, 403 (1925).
- (3) BJERRUM: *Z. physik. Chem.* **119**, 145 (1926).
- (4) RICHARDS AND ROWE: *J. Am. Chem. Soc.* **42**, 1121 (1920); **43**, 770 (1921).
- (5) BJERRUM: *Trans. Faraday Soc.* **23**, 445 (1927).
- (6) NERNST AND ORTHMANN: *Sitz. preuss. Akad. Wiss.*, p. 51 (1926).
- (7) NERNST AND ORTHMANN: *Sitz. preuss. Akad. Wiss.*, p. 136 (1927).
- (8) LANGE AND MESSNER: *Naturwissenschaften* **15**, 521 (1927).
LANGE AND MESSNER: *Z. Elektrochem.* **33**, 439 (1927).
- (9) GRONWALL, LAMER AND SANDVED: *Physik. Z.* **29**, 358 (1928).
- (10) LANGE AND MEIXNER: *Physik. Z.* **30**, 670 (1929).
- (11) HANSEN AND WILLIAMS: *J. Am. Chem. Soc.* **52**, 2767 (1930).
- (12) DEBYE AND PAULING: *J. Am. Chem. Soc.* **47**, 2129 (1925).
- (13) FOWLER: *Statistical Mechanics*, pp. 188-194, 314-321. Cambridge University Press, London (1929).
- (14a,b) DRUDE: *Wied. Ann.* **59**, 48 (1896).
- (14c) KOCKEL: *Ann. Physik.* **77**, 417 (1926).
- (14d) DEVOTO: *Gazz. chim. ital.* **60**, 208 (1930).
- (14e) ADAMS: *J. Am. Chem. Soc.* **48**, 621 (1926).

⁷ Since this article was submitted Lange and Streeck have published curves for $Mg(NO_3)_2$, $Ca(NO_3)_2$ and $Sr(NO_3)_2$ in *Naturwissenschaften* **19**, 359 (1931).

- (14f) International Critical Tables, Vol. VI, p. 78, 1929.
- (14g) CUTHBERTSON AND MAASS: *J. Am. Chem. Soc.* **52**, 483 (1930).
- (14h) DRAKE, PIERCE AND DOW: *Phys. Rev.* **35**, 613 (1930).
- (14i) WYMAN: *Phys. Rev.* **35**, 623 (1930).
- (15) LANGE AND ROBINSON: *J. Am. Chem. Soc.* **52**, 2811 (1930).
- (16) LANGE: *Z. Elektrochem.* **36**, 772 (1930).
- (17) LANGE AND MONHEIM: *Z. physik. Chem.* **149A**, 51 (1930).
- (18) LANGE AND STREECK: *Z. physik. Chem.* **151A**, 1 (1931).
- (19) LANGE AND ROUNSEFELL: *Z. physik. Chem.* **142A**, 351 (1929).
- (20) LANGE: *Fortschritte Chem. Physik. physik. Chem.* **19**, No. 6 (1928).
- (21) LANGE AND LEIGHTON: Unpublished measurements.
- (22) LANGE AND ROBINSON: Unpublished measurements.
- (23) LANGE AND ROBINSON: Unpublished measurements.
- (24) LANGE AND ROBINSON: *Z. physik. Chem.* **148A**, 97 (1930).
- (25) LANGE AND LEIGHTON: *Z. Elektrochem.* **34**, 566 (1928).
- (26) LANGE AND MONHEIM: *Z. physik. Chem.* **150A**, 349 (1931).
- (27) LANGE AND STREECK: *Z. physik. Chem.* **152A**, 1 (1931).
- (28) LANGE AND STREECK: *Naturwissenschaften* **19**, 359 (1931).
- (29) LEWIS AND RANDALL: *Thermodynamics*, p. 439. McGraw-Hill Book Company, New York (1923).
- (30) LANGE AND SHIBATA: *Z. physik. Chem.* **149A**, 465 (1930).
- (31) RICHARDS AND ROWE: *J. Am. Chem. Soc.* **44**, 684 (1922).
- (32) LATIMER AND BUFFINGTON: *J. Am. Chem. Soc.* **48**, 2297 (1926).
- (33) LANGE: *Z. physik. Chem.* **116**, 336 (1925).
- (34) HARNED: *J. Am. Chem. Soc.* **51**, 416 (1929).
- (35) HARNED AND ÅKERLOF: *Physik. Z.* **27**, 411 (1926).
- (36) NERNST: *Z. Elektrochem.* **33**, 428 (1927).
- (37) *Physik. Z.* **29**, 769 (1928).
- (38) ORTHMANN: *Ergebnisse exakt. Naturwiss.* **6**, 188 (1927).
- (39) LANGE AND ROBINSON: *J. Am. Chem. Soc.* **52**, 4218 (1930).
- (40) KOCKEL: *Ann. Physik.* **77**, 430 (1926).